

Documentatie tehnica aparat de sudura AS 250M

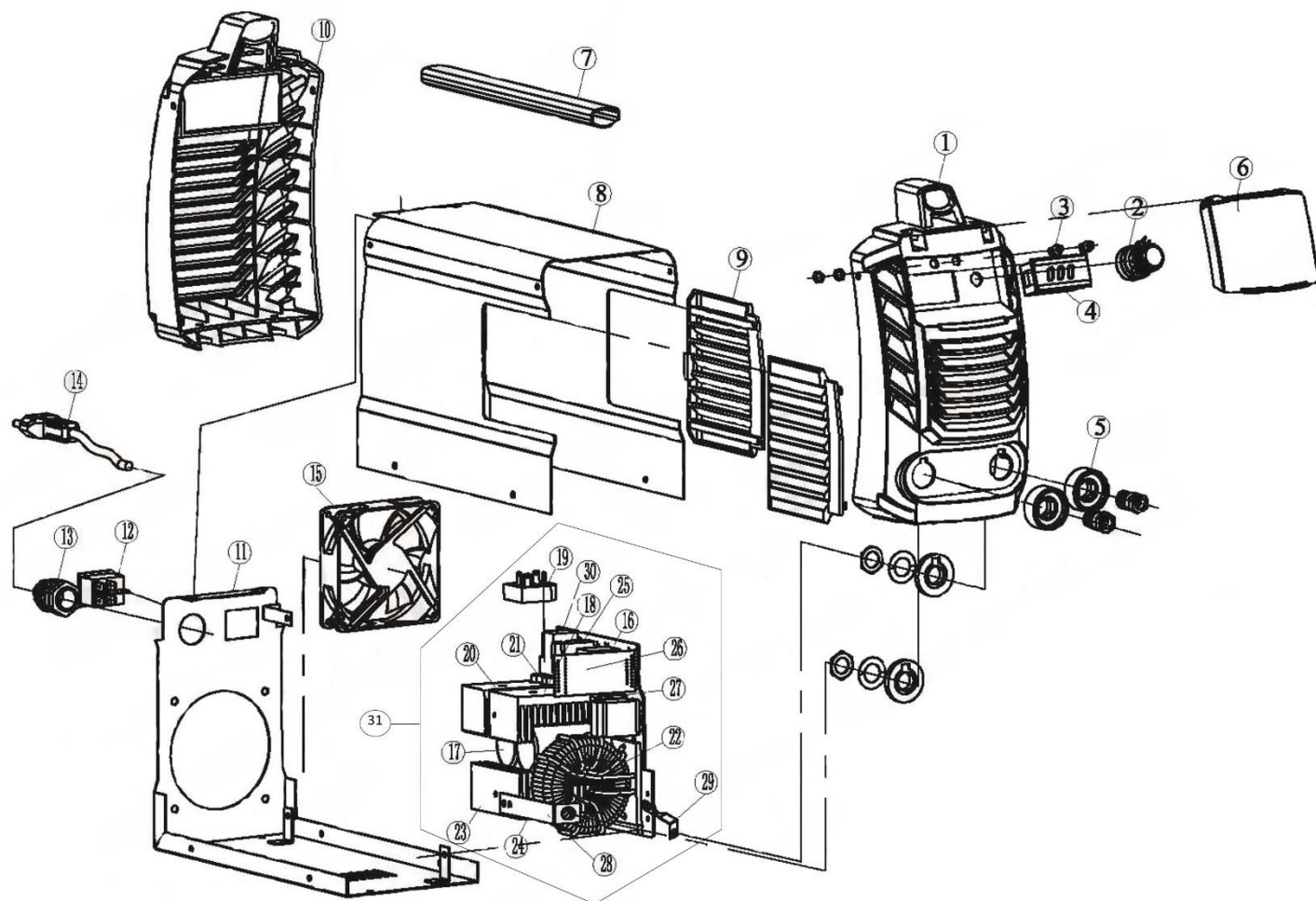

Nr.crt	Denumire produs	Product name	Cod comanda
1	carcasa fata	front panel	psas250m-1-1
2	potentiometru	potentiometer	psas250m-1-2
3	indicator led	indicator light	psas250m-1-3
4	display digital	digital displayer	psas250m-1-4
5	conector mama	plug	psas250m-1-5
6	capac	gauge cover	psas250m-1-6
7	maner	handle	psas250m-1-7
8	carcasa	ilehs enihcam	psas250m-1-8

Producător motoutilaje

Documentatie tehnică

9	capac ventilat	ventilating window	psas250m-1-9
10	carcasa spate	rear panel	psas250m-1-10
11	carcasa inferioara	machine bottom	psas250m-1-11
12	comutator on/off	power switch	psas250m-1-12
13	conector	waterproff joint	psas250m-1-13
14	cablu alimentare	power wire	psas250m-1-14
15	ventilator	fan	psas250m-1-15
16	placa de baza	PCB	psas250m-1-16
17	condensator	capacitor	psas250m-1-17
18	radiator	silicon bridge radiator	psas250m-1-18
19	punte redresoare	silicon bridge	psas250m-1-19
20	radiator tranzistor	IGBT radiator	psas250m-1-20
21	tranzistor	IGBT	psas250m-1-21
22	transformator	main transformer	psas250m-1-22
23	radiator	rectifier radiator	psas250m-1-23
24	conexiune conector	rectifier tube	psas250m-1-24
25	transformator	driver transformer	psas250m-1-25
26	placa de baza	control PCB	psas250m-1-26
27	condensator	CBB	psas250m-1-27
28	conector +	positive connector	psas250m-1-28
29	conector -	negative connector	psas250m-1-29
30	releu	relay	psas250m-1-30
31	ansamblu placa de baza	PCB assy	psas250m-1-31